



# Appendix 16

## Erosion and sediment control guidelines for earthworks

Contents	Page
<b>1.0 Introduction .....</b>	<b>3</b>
<b>2.0 General guidelines.....</b>	<b>3</b>
<b>3.0 Runoff control methods .....</b>	<b>4</b>
3.1 Diversion bunds/channels .....	4
3.2 Contour drains.....	4
<b>4.0 Sediment control methods.....</b>	<b>5</b>
4.1 Silt fences.....	5
4.2 Haybales .....	6
4.3 Earth bunds.....	6
4.4 Sediment ponds .....	7
<b>5.0 Application to typical house site.....</b>	<b>8</b>
<b>6.0 Keeping the roads clean .....</b>	<b>9</b>
<b>7.0 Pumping water from the site.....</b>	<b>10</b>
<b>8.0 Additional information.....</b>	<b>10</b>

**Plan modification annotations**

 indicates where content is affected by proposed plan modification x. refer to plan modification folder or website for details.

 indicates where the content is part of plan modification x, which is subject to appeal.

Underlined content to be inserted.

~~Struck through~~ content to be deleted.



## 1.0 Introduction

Uncontrolled earthworks activities can remove or smother valuable vegetation and cause silt runoff into streams and coastal waters. This silt can smother aquatic life and affect fish feeding and breeding areas. If a number of earthworks activities are occurring over time in the same area, there will be a cumulative impact which will compound the adverse effects on the environment.

By choosing the right methods when undertaking earthworks you can prevent unnecessary soil erosion and help the community protect the streams and coastal areas of the islands. This publication provides information about erosion and sediment control measures to assist you when planning and carrying out earthworks.

*The landowner and the earthworks contractor are both responsible for making sure that any activity disturbing the soil is carried out in a way to prevent soil erosion and to stop sediment entering waterways.*

A resource consent will be required for some earthworks, depending on the area where the work is to take place and the size of the job. You should check with the council to find out whether a consent is needed. For very large earthworks, works within floodplains for watercourses (including diversion) and cultivation of soil for commercial crop production, you may also require a consent from the Auckland Regional Council. The ARC has comprehensive guidelines which will be helpful for larger projects.

*Regardless of the size of the earthworks, you are required to take the appropriate measures to prevent soil loss and erosion. This applies even when a resource consent is not needed.*

Some facts about siltation:

- Earthwork sites can produce up to 100 times as much sediment as from grassed areas.
- Doubling the angle of the slope produces more than a two-fold increase in silt.

## 2.0 General guidelines

1. Keep the area of earthworks small. Stage earthworks and expose only as much ground is needed at any one time.
2. Keep as much grass or natural vegetation as possible around the sides and bottom of a site. Do not mow or park machines or vehicles on this during the project.
3. Divert runoff around the bare areas of the site using diversion bunds / channels, or contour drains. Details on these each of these measures can be found in the section of runoff control below.
4. Install a stabilised entranceway (gravel/wooden planks etc) prior to commencing work to reduce dirt tracking onto the road.
5. Retain sediment on the site. Use earth bunds, silt ponds, silt fences or haybales and install them as close to bare areas as practicable. Details on each of these measures can be found in the section on sediment control below.
6. Take extra care near watercourses.
7. Cover any soil stockpiles or stabilise with mulch or vegetation.
8. Ensure that earthworks equipment is only washed in areas of the site which have appropriate sediment controls. Similarly do not leave muddy equipment standing on areas of the site which do not have appropriate sediment controls.
9. Retain and maintain the control measures until all bare areas on the site have been protected against erosion (by concrete pad, gravel, seal, grass, vegetation etc). Cover bare areas as quickly as possible.
10. At the building stage, install spouting, downpipes and temporary pipes as soon as the roof is on to convey roof water away from bare areas and to an erosion proof outfall.

### 3.0 Runoff control methods

#### 3.1 Diversion bunds/channels

1. These are used to transfer all runoff around a site, to silt ponds etc.
2. They need to be big enough to take the flow from a 20 year storm event. The design flow, Q, can be approximated from the formula:

$$Q = 0.15 \times \text{Area (ha)} \text{ (m}^3\text{/s)}$$

Indicative channel capacities for different flows are as follows (these assume a grassed channel on a 2 per cent grade, side slopes of 1:1 for the bund and 3:1 for the channel):

Depth (m)	Flow (m <sup>3</sup> /s)
0.2	0.1
0.3	0.3
0.4	0.6

3. Soil channels that have a slope of more than 2 per cent need to be protected (armoured) against erosion. This can be achieved by laying and pinning fabric eg polythene, grassing, placing rock etc.

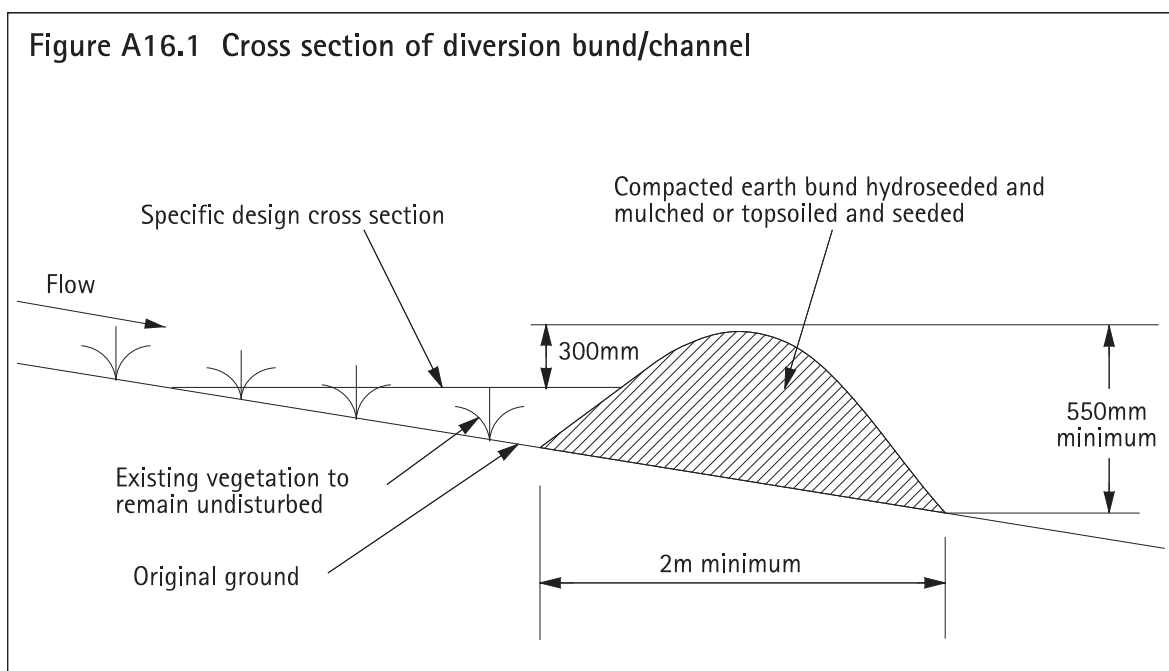

#### 3.2 Contour drains

1. These are temporary runoff control measures and are either constructed daily or in the event of rain to intercept runoff on the site.
2. Intercepted runoff must be directed to a stable outlet.
3. They do not need calculations for their implementation. Try to keep their grade at 2 per cent or less, and install more drains as the land becomes steeper.

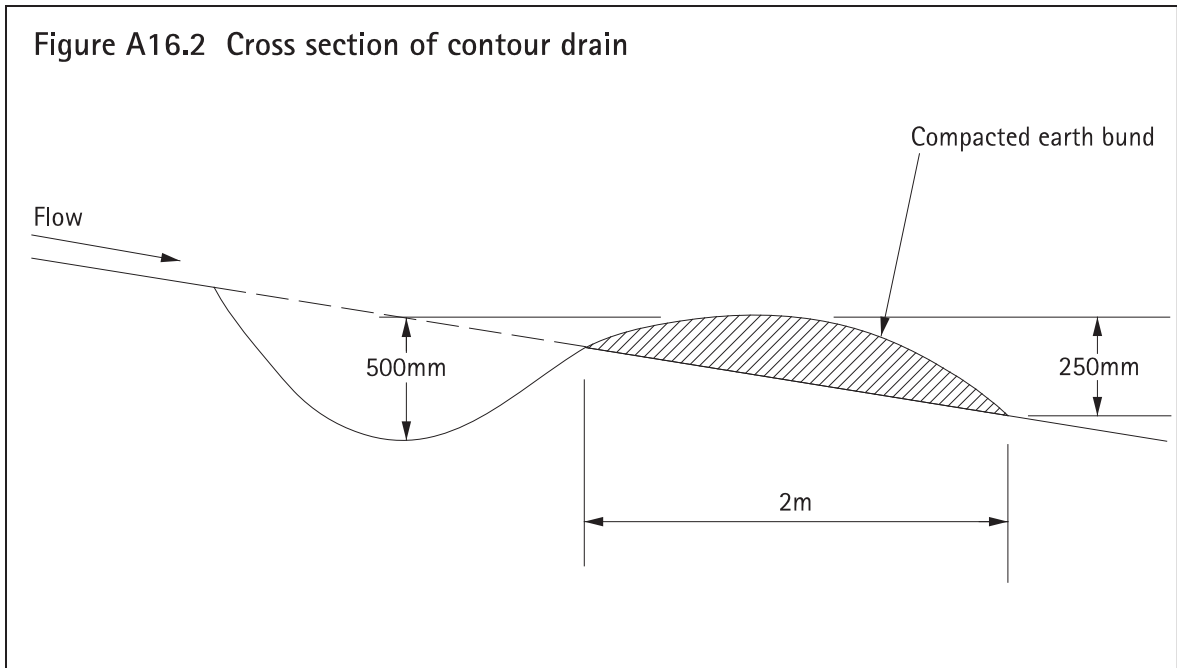

## 4.0 Sediment control methods

### 4.1 Silt fences

1. For catchments of 0.5 ha or less. Construct on the contour.
2. Make sure that the fabric is well dug in (200mm deep and backfilled).
3. Posts/waratahs should be no more than 2m apart.
4. The fences can be strengthened with tensioned wire, and with chain mesh netting.

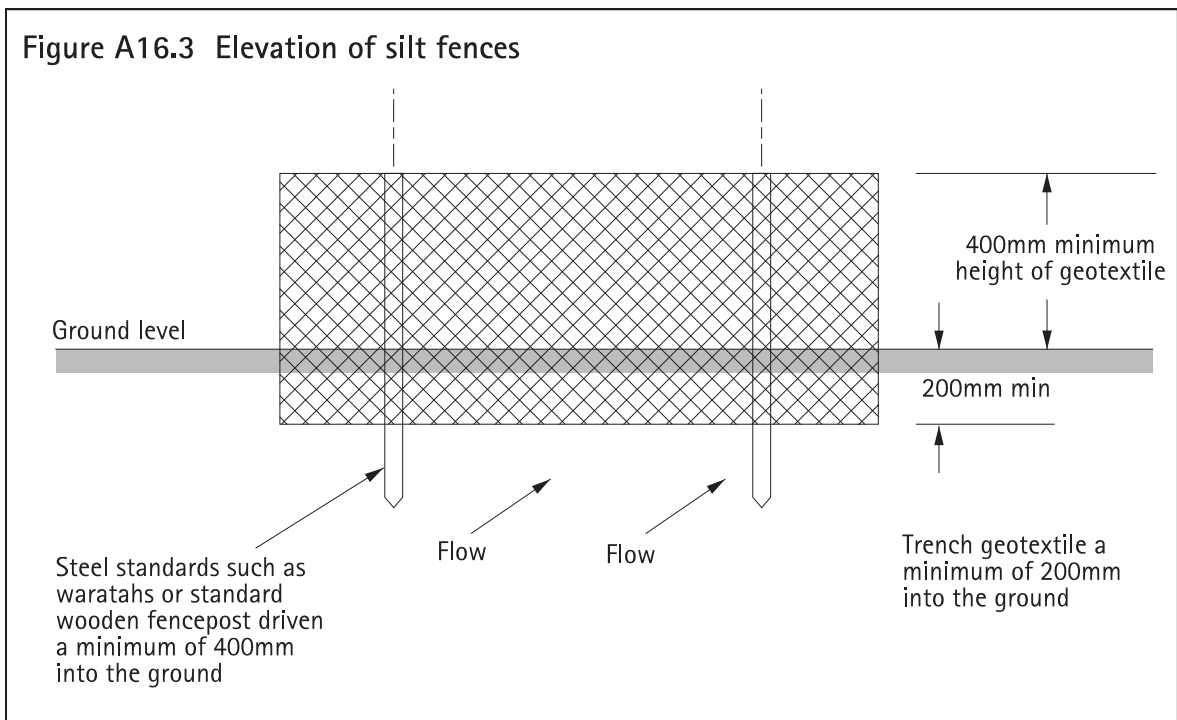

## 4.2 Haybales

1. These should be used only when there is 20m or less length of slope above them and where the slope is less than 20 per cent.
2. They should be placed on the contour and anchored by staking.

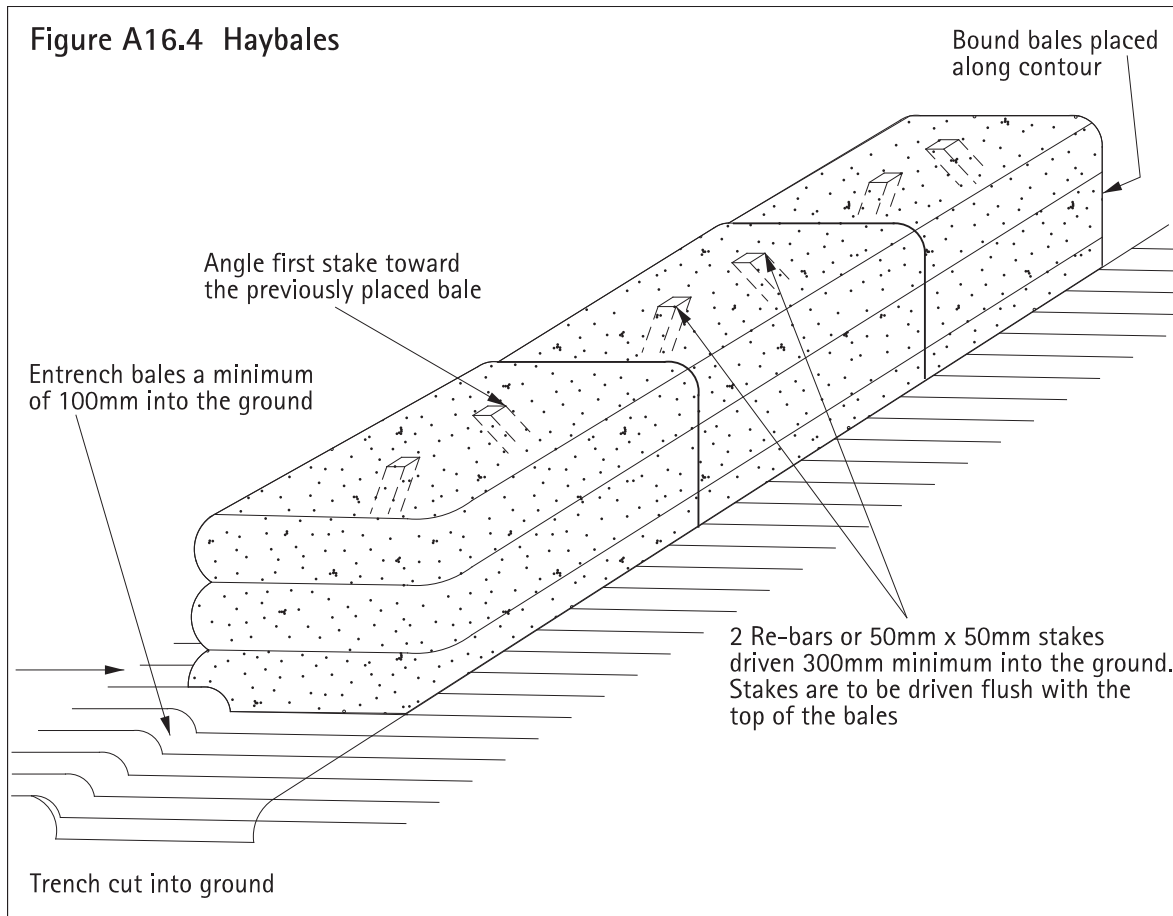

## 4.3 Earth bunds

1. These are mini silt ponds to retain sediment.
2. Catchment should be 0.3 ha or less.
3. They should be cleaned out when 20 per cent full of deposited sediment.

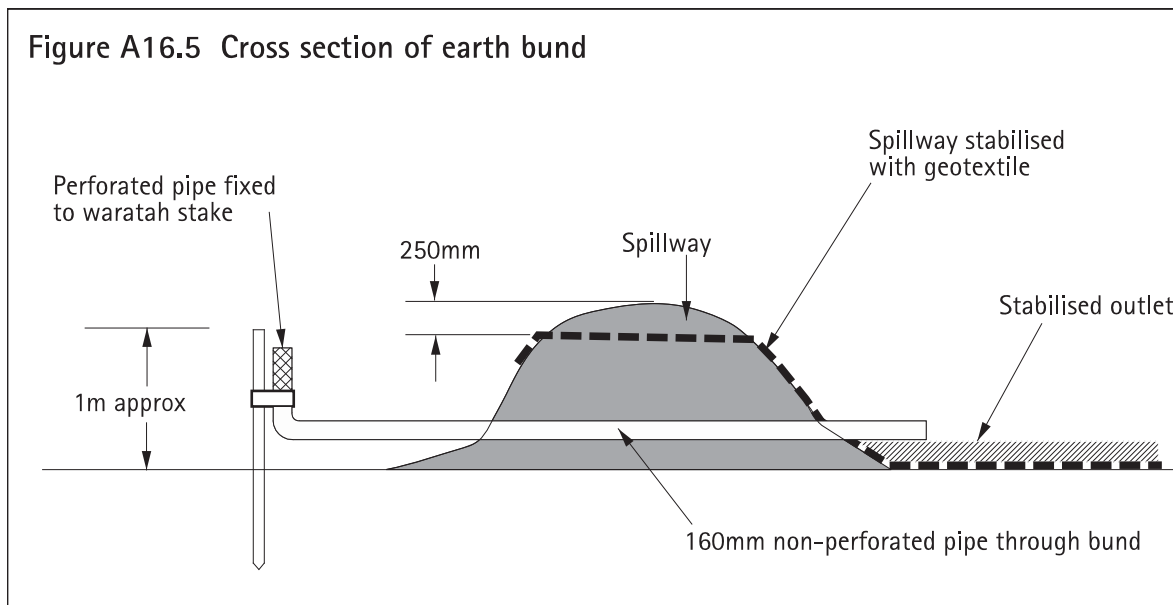

#### 4.4 Sediment ponds

1. These are used when catchments are greater than 0.3 ha.
2. The maximum catchment should be 5 ha.
3. Do not construct in streams.
4. Capacity is generally 2m<sup>3</sup> per 100m<sup>2</sup> of site area.
5. They should be cleaned out when 20 per cent full of deposited settlement.

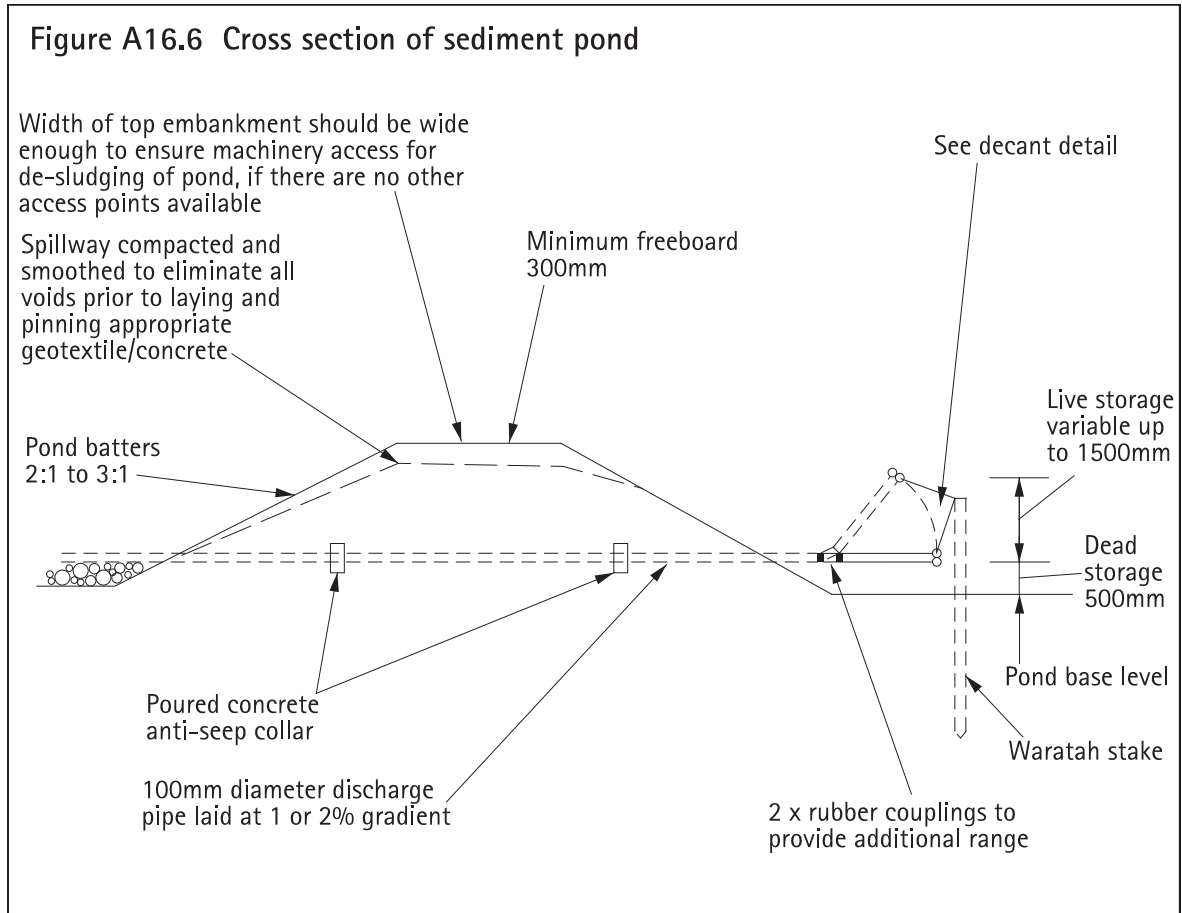

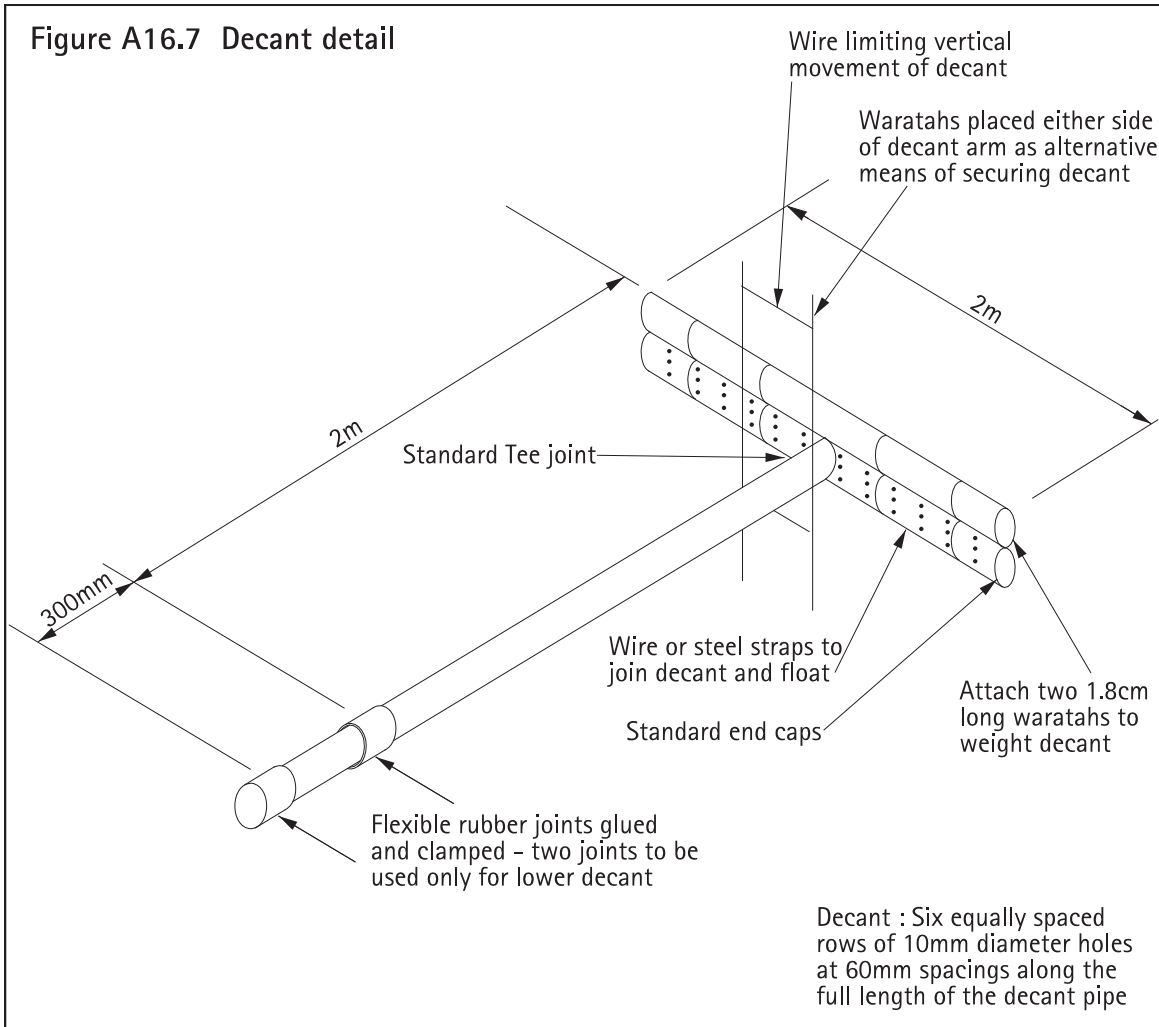

## 5.0 Application to typical house site

Figure A16.8 shows how the runoff and sediment controls can be applied to a typical house site.

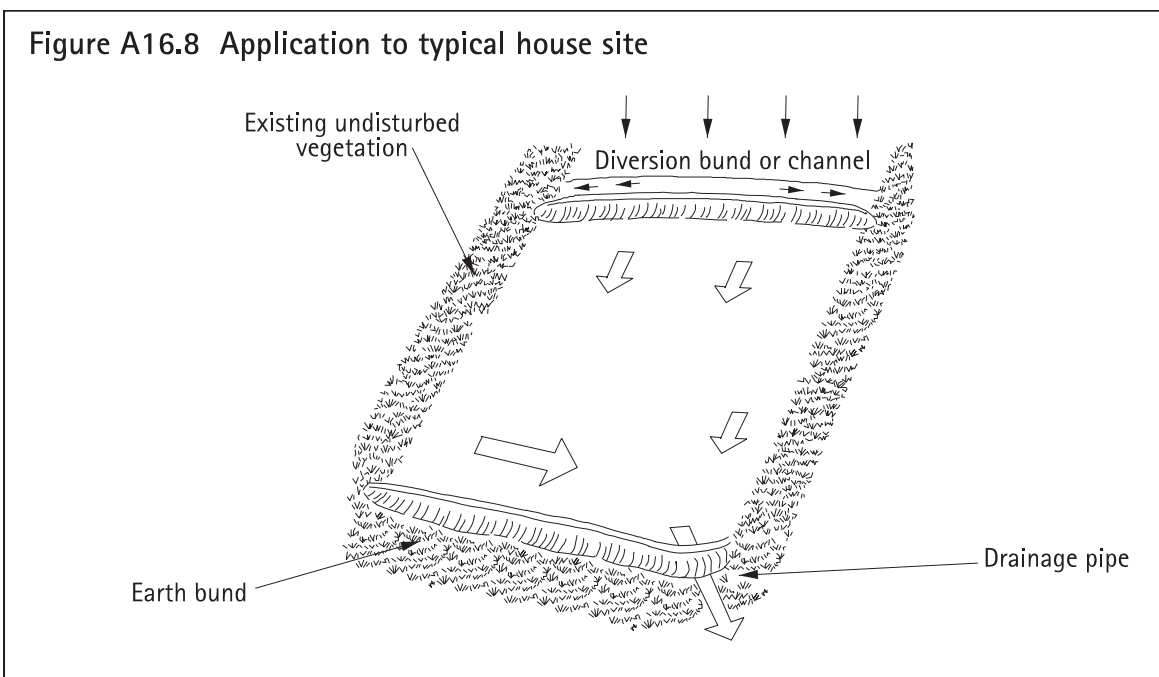



## 6.0 Keeping the roads clean

It is important that soil from the site is not spread onto the road by vehicle tyres. To prevent this from occurring a stabilised entranceway must be built. The simplest method is to spread metal aggregate on all exitways from the site, where the soil will have a chance to fall off before the vehicle enters the road. Other methods for larger sites are cattle grids or wheel washes. The site manager or site owner is responsible for cleaning up any spilt soil or other materials that get on to the road from the site. Remember also to protect the footpath, berm and kerb from damage by crossing vehicles.

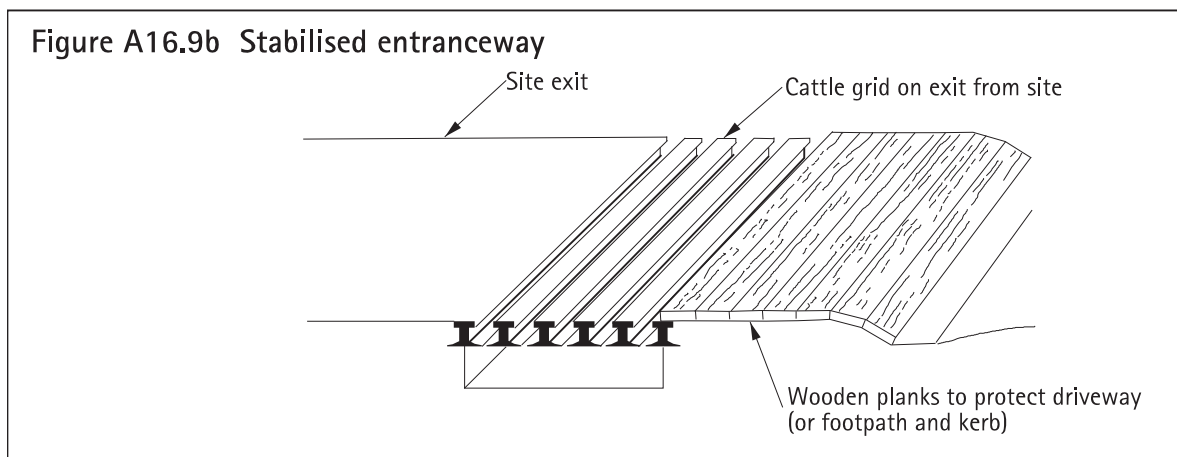
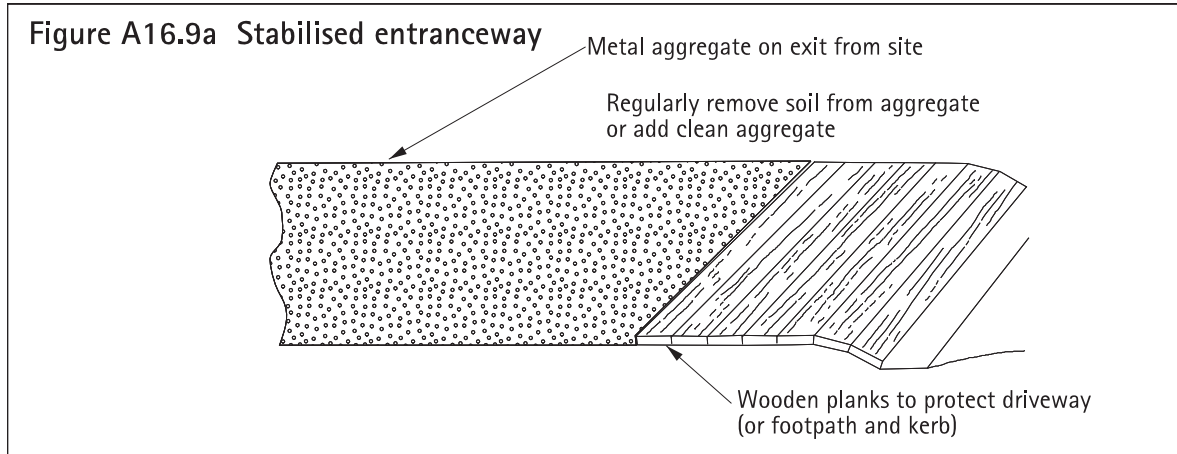

## 7.0 Pumping water from the site

If it is necessary to remove water from trenches or other areas of the site, then this should be done in a manner to prevent sediment in the water from entering any drain or watercourse. Water should not be taken from the bottom of any trench and sediment should be properly filtered out from the dirty water by some appropriate means such as the use of silt fences. It will often be necessary to pump water into a tank and discharge it into a silt pond.

Figure A16.10 Pumping water from the site

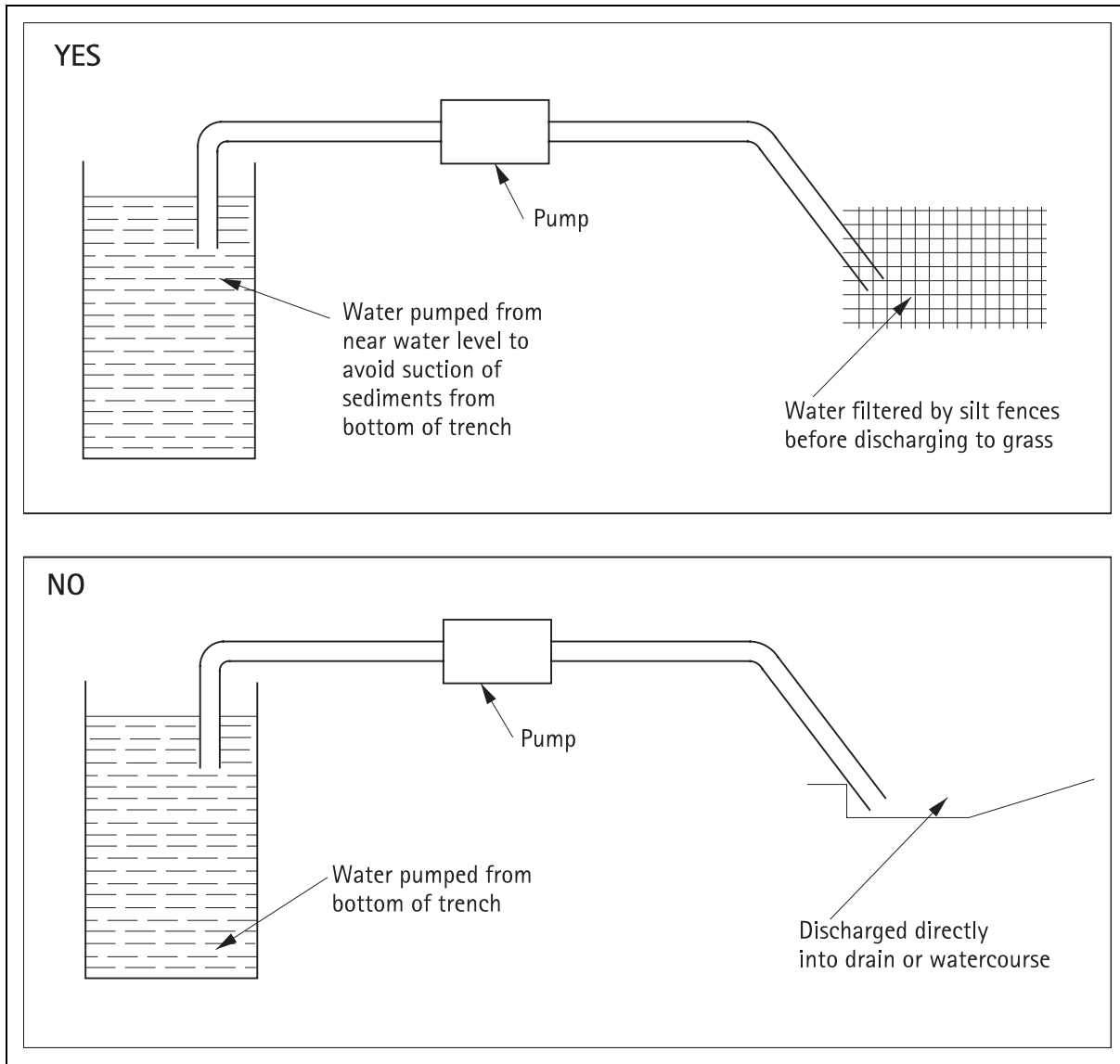

## 8.0 Additional information

For more details about erosion and sediment control measures, see the Auckland Regional Council publication “Erosion and Sediment Control Guidelines for Land Disturbing Activities in the Auckland Region” (Technical Publication Number 90).